



Single Socket and Horizontal Metering

MEG Approved



Single Socket Metering—MEG Approved



Application Information

GE's Single Socket Metering products are designed for residential use. They are UL labeled and are manufactured with surface mounted outdoor enclosures. The units in this brochure are approved by MEG.

Our products range from 125A to 320A and are available in single phase or three phase.

Specifications and Features

- Single Phase or Three Phase
- UL Listed (Panelboards No. 67)
- Tested and UL listed up to 10kAIC short circuit rating
- Selected items are utility approved
- NEMA 3R enclosure
- Integral duplex ground extruded in neutral lug
- G90 galvanized bridge provides superior corrosion resistance
- Heavy duty lug screws provide stronger connection component for reliable termination
- 125A units have horn bypass kit that is field installable by changing slide-nut
- 200A units have jaws made of copper plated alloy and have reinforcing springs to help maintain electrical connections
- 200A units have slide-nuts that allow for ease of installation of conductors and helps eliminate lost components



Single Socket Metering—MEG Approved

Single Socket Nomenclature

Sockets with 4 Jaws/Terminals

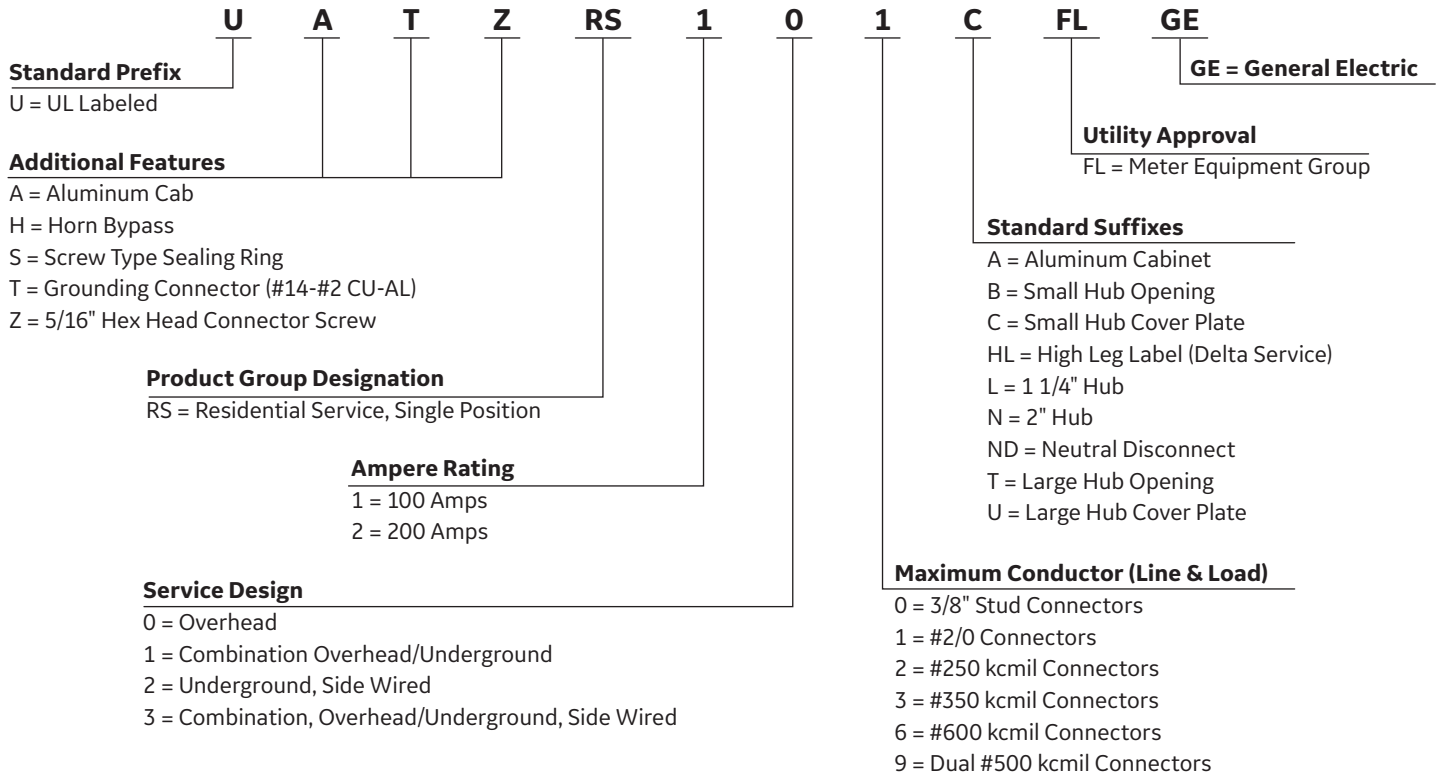

Sockets with 4, 5 or 7 Jaws/Terminals

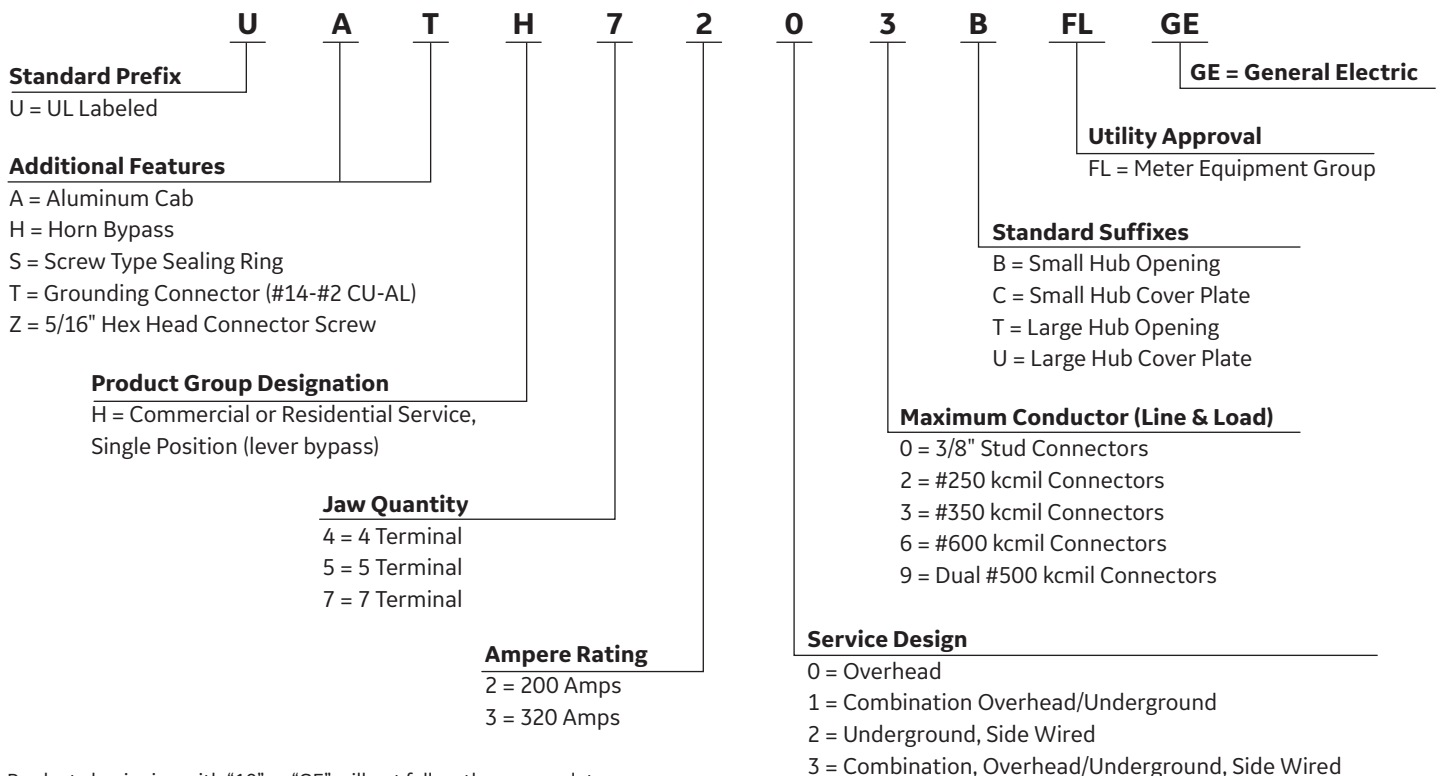

Products beginning with "10" or "GE" will not follow the nomenclature.

Single Socket Metering—MEG Approved

Single Phase, 600V

Amp	Catalog Number Ringless	Wire Range (CU/AL)	Overhead/Underground Line Feed	Ground Range (CU/AL)	Triplex Ground	No. of Terminals	Lever Bypass	Horned Bypass	Hub Type	Enclosure N3R	UL & Utility Approved
125	UATZRS101CFLGE	#8-2/0	Top/Bottom	(1) #14-2	Y	4	N	N	Small Hub Cover Plate	Aluminum	UL, MEG
	UTZRS101CFLGE	#8-2/0	Top/Bottom	(1) #14-2	Y	4	N	N	Small Hub Cover Plate	G90 Steel	
200	UATH4203BFLGE	#6-350MCM	Top/Bottom	(1) #14-2	Y	4	Y	N	Small Hub Opening	Aluminum	UL, MEG
	UATH4203TFLGE	#6-350MCM	Top/Bottom	(1) #14-2	Y	4	Y	N	Large Hub Opening		
	UATH4213CFLGE	#6-350MCM	Top/Bottom	(1) #14-2	Y	4	Y	N	Small Hub Cover Plate		
	UATH4213UFLGE	#6-350MCM	Top/Bottom	(1) #14-2	Y	4	Y	N	Large Hub Cover Plate		
	UATRS202BFLGE	#8-250MCM	Top/Bottom	(1) #14-2	Y	4	N	N	Small Hub Opening		
	UATRS212CFLGE	#8-250MCM	Top/Bottom	(1) #14-2	Y	4	N	N	Small Hub Cover Plate		
	UATRS213AFLGE	#8-350MCM	Bottom	(1) #14-2	Y	4	N	N	Solid Top		
	UATRS213CFLGE	#8-350MCM	Top/Bottom	(1) #14-2	Y	4	N	N	Small Hub Cover Plate		
	UATRS223AFLGE	#8-350MCM	Bottom	(1) #14-2	Y	4	N	N	Solid Top		
	UT92197CCFLGE	#8-350MCM	Top/Bottom	(1) #14-2	Y	4	N	N	(2) Small Hub Cover Plates		
	UTH4203BFLGE	#6-350MCM	Top/Bottom	(1) #14-2	Y	4	Y	N	Small Hub Opening		
	UTH4203TFLGE	#6-350MCM	Top/Bottom	(1) #14-2	Y	4	Y	N	Large Hub Opening		
	UTH4213CFLGE	#6-350MCM	Top/Bottom	(1) #14-2	Y	4	Y	N	Small Hub Cover Plate		
	UTH4213UFLGE	#6-350MCM	Top/Bottom	(1) #14-2	Y	4	Y	N	Large Hub Cover Plate		
	UTRS213AFLGE	#8-350MCM	Bottom	(1) #14-2	Y	4	N	N	Solid Top		
	UTRS213CFLGE	#8-350MCM	Top/Bottom	(1) #14-2	Y	4	N	N	Small Hub Cover Plate		
UTRS223AFLGE	#8-350MCM	Bottom	(1) #14-2	Y	4	N	N	Solid Top			
320	1008836GE ¹	Studs - (1) 600MCM or (2) 350MCM	Top/Bottom	(1) #14 -1/0	Y	4	Y	N	Large Hub Cover Plate	G90 Steel	UL, MEG
	1008837GE ¹	Studs - (1) 600MCM or (2) 350MCM	Top/Bottom	(1) #14 -1/0	Y	4	Y	N	Large Hub Cover Plate	Aluminum	
	UATH4300TFLGE ¹	Studs - (1) 600MCM or (2) 350MCM	Top/Bottom	(1) #14 -1/0	Y	4	Y	N	Large Hub Opening	Aluminum	
	UTH4300TFLGE ¹	Studs - (1) 600MCM or (2) 350MCM	Top/Bottom	(1) #14-1/0	Y	4	Y	N	Large Hub Opening	G90 Steel	

¹Lugs not included. This product comes with studs only. Order lugs separately, see accessories on page 12. 1 Lug per kit, order appropriate QTY needed. For example, order 3 lugs (A, C, N) if meter is single-phase or 4 lugs (A, B, C, N) if meter is three-phase.

Single Socket Metering—MEG Approved (continued)

Three Phase, 600V

Amp	Catalog Number Ringless	Wire Range (CU/AL)	Overhead/Underground Line Feed	Ground Range (CU/AL)	Triplex Ground	No. of Terminals	Lever Bypass	Horned Bypass	Hub Type	Enclosure N3R	UL & Utility Approved
200	UATH7203BFLGE	#6-350MCM	Top/Bottom	(1) #14-2	Y	7	Y	N	Small Hub Opening	Aluminum	UL, MEG
	UATH7203TFLGE	#6-350MCM	Top/Bottom	(1) #14-2	Y	7	Y	N	Large Hub Opening		
	UATH7213CFLGE	#6-350MCM	Top/Bottom	(1) #14-2	Y	7	Y	N	Small Hub Cover Plate	G90 Steel	
	UATH7213UFLGE	#6-350MCM	Top/Bottom	(1) #14-2	Y	7	Y	N	Large Hub Cover Plate		
	UTH7203BFLGE	#6-350MCM	Top/Bottom	(1) #14-2	Y	7	Y	N	Small Hub Opening	G90 Steel	
	UTH7203TFLGE	#6-350MCM	Top/Bottom	(1) #14-2	Y	7	Y	N	Large Hub Opening		
320	UATH7300TFLGE ¹	Studs - (1) 600MCM or (2) 350MCM	Top/Bottom	(1) #14 -1/0	Y	7	Y	N	Large Hub Opening	Aluminum	UL, MEG
	UATH7300UFLGE ¹	Studs - (1) 600MCM or (2) 350MCM	Top/Bottom	(1) #14 -1/0	Y	7	Y	N	Large Hub Cover Plate		
	UATH7330UFLGE	Studs - (1) 600MCM or (2) 350MCM	Side	(1) #14 -1/0	Y	7	Y	N	Large Hub Cover Plate	G90 Steel	
	UTH7300TFLGE ¹	Studs - (1) 600MCM or (2) 350MCM	Top/Bottom	(1) #14-1/0	Y	7	Y	N	Large Hub Opening		
	UTH7330UFLGE ¹	Studs - (1) 600MCM or (2) 350MCM	Top/Bottom	(1) #14-1/0	Y	7	Y	N	Large Hub Cover Plate		

Single or Three Phase, 600V

Amp	Catalog Number Ringless	Wire Range (CU/AL)	Overhead/Underground Line Feed	Ground Range (CU/AL)	Triplex Ground	No. of Terminals	Lever Bypass	Horned Bypass	Hub Type	Enclosure N3R	UL & Utility Approved
200	UATH5203BFLGE	#6-350MCM	Top/Bottom	(1) #14-2	Y	5	Y	N	Small Hub Opening	Aluminum	UL, MEG
	UATH5203TFLGE	#6-350MCM	Top/Bottom	(1) #14-2	Y	5	Y	N	Large Hub Opening		
	UATH5213CFLGE	#6-350MCM	Top/Bottom	(1) #14-2	Y	5	Y	N	Small Hub Cover Plate	G90 Steel	
	UATH5213UFLGE	#6-350MCM	Top/Bottom	(1) #14-2	Y	5	Y	N	Large Hub Cover Plate		
	UTH5203BFLGE	#6-350MCM	Top/Bottom	(1) #14-2	Y	5	Y	N	Small Hub Opening	G90 Steel	
	UTH5203TFLGE	#8-350MCM	Top/Bottom	(1) #14-2	Y	5	Y	N	Large Hub Opening		
	UTH5213CFLGE	#6-350MCM	Top/Bottom	(1) #14-2	Y	5	Y	N	Small Hub Cover Plate	G90 Steel	
	UTH5213UFLGE	#6-350MCM	Top/Bottom	(1) #14-2	Y	5	Y	N	Large Hub Cover Plate		
320	UATH5300TFLGE ¹	Studs - (1) 600MCM or (2) 350MCM	Top/Bottom	(1) #14 -1/0	Y	5	Y	N	Large Hub Opening	Aluminum	UL, MEG
	UATH5330UFLGE ¹	Studs - (1) 600MCM or (2) 350MCM	Top/Bottom	(1) #14 -1/0	Y	5	Y	N	Large Hub Cover Plate		
	UTH5300TFLGE ¹	Studs - (1) 600MCM or (2) 350MCM	Top/Bottom	(1) #14-1/0	Y	5	Y	N	Large Hub Opening	G90 Steel	
	UTH5330UFLGE ¹	Studs - (1) 600MCM or (2) 350MCM	Top/Bottom	(1) #14-2	Y	5	Y	N	Large Hub Cover Plate		

¹Lugs not included. This product comes with studs only. Order lugs separately, see accessories on page 12. 1 Lug per kit, order appropriate QTY needed. For example, order 3 lugs (A, C, N) if meter is single-phase or 4 lugs (A, B, C, N) if meter is three-phase.

Single Socket Metering—MEG Approved

Enclosure Style

Catalog Number	Height (A) Inches	Width (B) Inches	Depth (C) Inches	Gross Weight lbs.	Enclosure Style
1008836GE	36.63	15.00	6.50	41.00	C
1008837GE	36.63	15.00	6.50	26.00	C
UATH4203BFLGE	19.00	10.50	4.94	18.00	A
UATH4203TFLGE	19.00	10.50	4.94	18.00	A
UATH4213CFLGE	19.00	13.00	4.94	18.00	A
UATH4213UFLGE	19.00	13.00	4.94	18.00	A
UATH4300TFLGE	34.50	13.00	4.94	39.00	F
UATH5203BFLGE	19.00	10.50	4.94	17.00	A
UATH5203TFLGE	19.00	10.50	4.94	17.00	A
UATH5213CFLGE	19.00	13.00	4.94	18.00	A
UATH5213UFLGE	19.00	13.00	4.94	18.00	A
UATH5300TFLGE	34.50	13.00	4.94	18.00	A
UATH5330UFLGE	39.88	20.00	6.50	36.00	C
UATH7203BFLGE	19.00	10.50	4.94	18.00	A
UATH7203TFLGE	19.00	10.50	4.94	18.00	A
UATH7213CFLGE	19.00	13.00	5.00	18.00	A
UATH7213UFLGE	19.00	13.00	5.00	18.00	A
UATH7300TFLGE	34.50	15.00	5.69	23.00	F
UATH7300UFLGE	34.50	15.00	5.69	23.00	C
UATH7330UFLGE	39.88	20.00	6.50	36.00	C
UATRS202BFLGE	14.00	8.00	4.38	11.00	A
UATRS212CFLGE	14.00	11.00	4.38	9.00	A
UATRS213AFLGE	15.00	11.00	4.38	9.00	A
UATRS213CFLGE	15.00	11.00	4.38	9.00	A
UATRS223AFLGE	13.00	13.00	4.38	10.00	D
UATZRS101CFLGE	10.90	8.00	3.50	7.00	A
UT92197CCFLGE	17.13	13.00	4.94	18.00	D
UTH4203BFLGE	19.00	10.50	4.94	23.00	A
UTH4203TFLGE	19.00	10.50	4.94	23.00	A
UTH4213CFLGE	19.00	13.00	4.94	28.00	A
UTH4213UFLGE	19.00	13.00	4.94	28.00	A
UTH4300TFLGE	34.50	13.00	4.94	32.00	F
UTH5203BFLGE	19.00	10.50	4.94	23.00	A
UTH5203TFLGE	19.00	10.50	4.94	23.00	A
UTH5213CFLGE	19.00	13.00	4.94	25.00	A
UTH5213UFLGE	19.00	13.00	4.94	25.00	A
UTH5300TFLGE	34.50	13.00	4.94	32.00	F
UTH5330UFLGE	39.88	20.00	6.50	46.00	C
UTH7203BFLGE	19.00	10.50	4.94	23.00	A
UTH7203TFLGE	19.00	10.50	4.94	23.00	A
UTH7300TFLGE	34.50	15.00	5.69	35.00	F
UTH7330UFLGE	39.90	20.00	6.50	64.00	C
UTRS213AFLGE	15.00	11.00	4.38	14.00	A
UTRS213CFLGE	15.00	11.00	4.38	14.00	A
UTRS223AFLGE	13.00	13.00	4.94	15.00	D
UTZRS101CFLGE	10.88	8.00	3.50	7.00	A

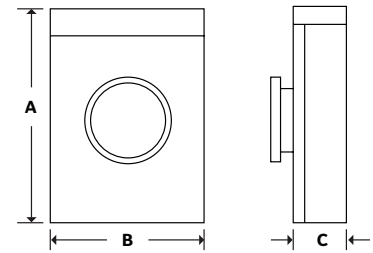

Figure A

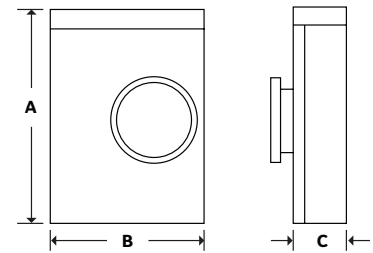

Figure C

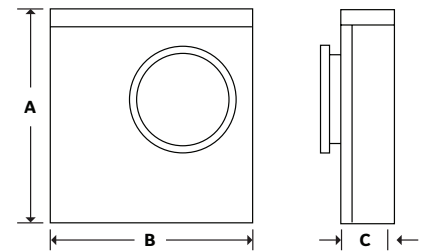

Figure D

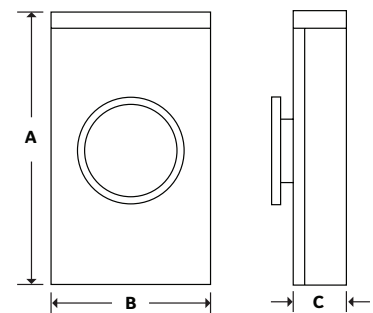

Figure F

Single Socket Metering—MEG Approved

Knockout Drawings and Dimensions

Catalog Number	Knockout Figure
1008836GE	AF
1008837GE	AF
UATH4203BFLGE	Z
UATH4203TFLGE	Z
UATH4213CFLGE	AG
UATH4213UFLGE	AG
UATH4300TFLGE	O
UATH5203BFLGE	Z
UATH5203TFLGE	Z
UATH5213CFLGE	N
UATH5213UFLGE	N
UATH5300TFLGE	O
UATH5330UFLGE	V
UATH7203BFLGE	Z
UATH7203TFLGE	Z
UATH7213CFLGE	O
UATH7213UFLGE	O
UATH7300TFLGE	O
UATH7300UFLGE	O
UATH7330UFLGE	AM
UATRS202BFLGE	AA
UATRS212CFLGE	AB
UATRS213AFLGE	AC
UATRS213CFLGE	AC
UATRS223AFLGE	Y
UATZRS101CFLGE	W
UT92197CCFLGE	AE
UTH4203BFLGE	Z
UTH4203TFLGE	Z
UTH4213CFLGE	N
UTH4213UFLGE	N
UTH4300TFLGE	O
UTH5203BFLGE	Z
UTH5203TFLGE	Z
UTH5213CFLGE	N
UTH5213UFLGE	N
UTH5300TFLGE	O
UTH5330UFLGE	V
UTH7203BFLGE	Z
UTH7203TFLGE	Z
UTH7300TFLGE	O
UTH7330UFLGE	V
UTRS213AFLGE	AC
UTRS213CFLGE	AC
UTRS223AFLGE	Y
UTZRS101CFLGE	AD

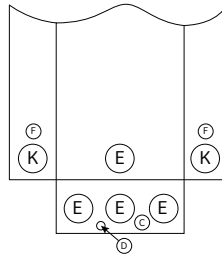

Figure N

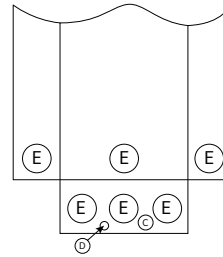

Figure O

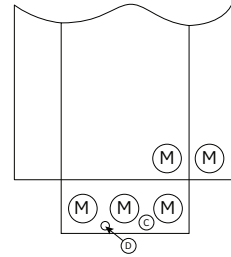

Figure V

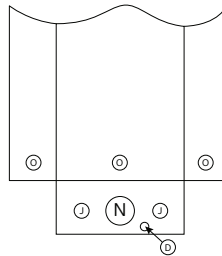

Figure W

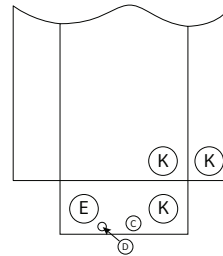

Figure Y

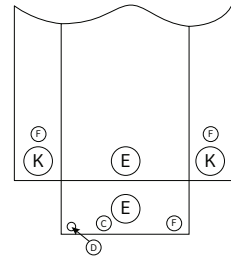

Figure Z

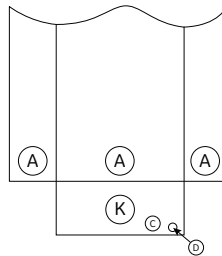

Figure AA

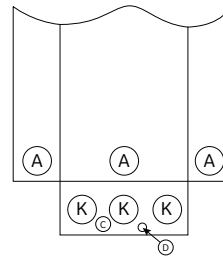

Figure AB

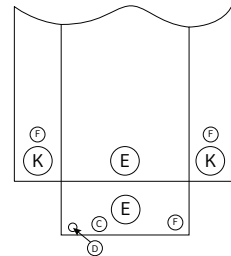

Figure AC

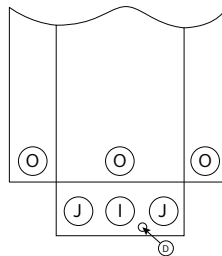

Figure AD

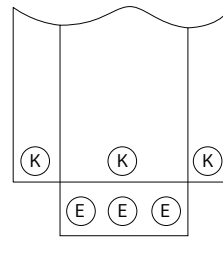

Figure AE

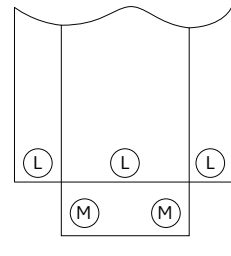

Figure AF

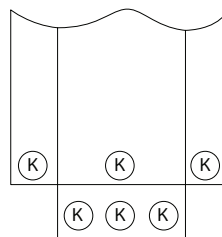

Figure AG

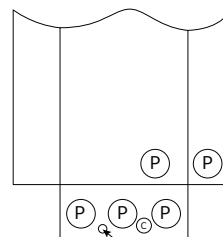

Figure AM

Knockout Dimensions (inches)
A = 1-1/2, 2, 2-1/2
C = 1/2
D = 5/16
E = 2, 2-1/2, 3
F = 1/2, 3/4
I = 1-1/4, 1-1/2, 2
J = 1/2, 3/4, 1, 1-1/4
K = 1, 1-1/4, 1-1/2, 2, 2-1/2
L = 2, 2-1/2, 3, 3-1/2
M = 2, 2-1/2, 3, 3-1/2
N = 1, 1-1/4, 1-1/2, 2
O = 1/2, 3/4, 1, 1-1/4, 1-1/2
P = 4, 3-1/2, 3, 2-1/2, 2

Horizontal Metering—MEG Approved



Application Information

GE's Horizontal Metering products offer 600V metering solutions for strip malls and small commercial buildings requiring two to six metering locations. These products accept meters with 100A to 200A ratings and they have a compact vertical footprint. The products in this brochure meet all of the MEG utility specification requirements.

Specifications and Features

- Single Phase
- Top/Bottom Feed
- UL Listed
- Selected items are utility approved
- NEMA 3R enclosure
- Multiple hub opening and closure plate sizes available
- Hub opening in top endwall, requires use of a bolt-on hub or closing plate
- 1Ø, 600 Vac maximum
- Main lugs only



- End or center feed
- Overhead and underground service feeds
- 10 kAIC short circuit rating (or higher with utility approval)

Horizontal Metering—MEG Approved

Horizontal Nomenclature

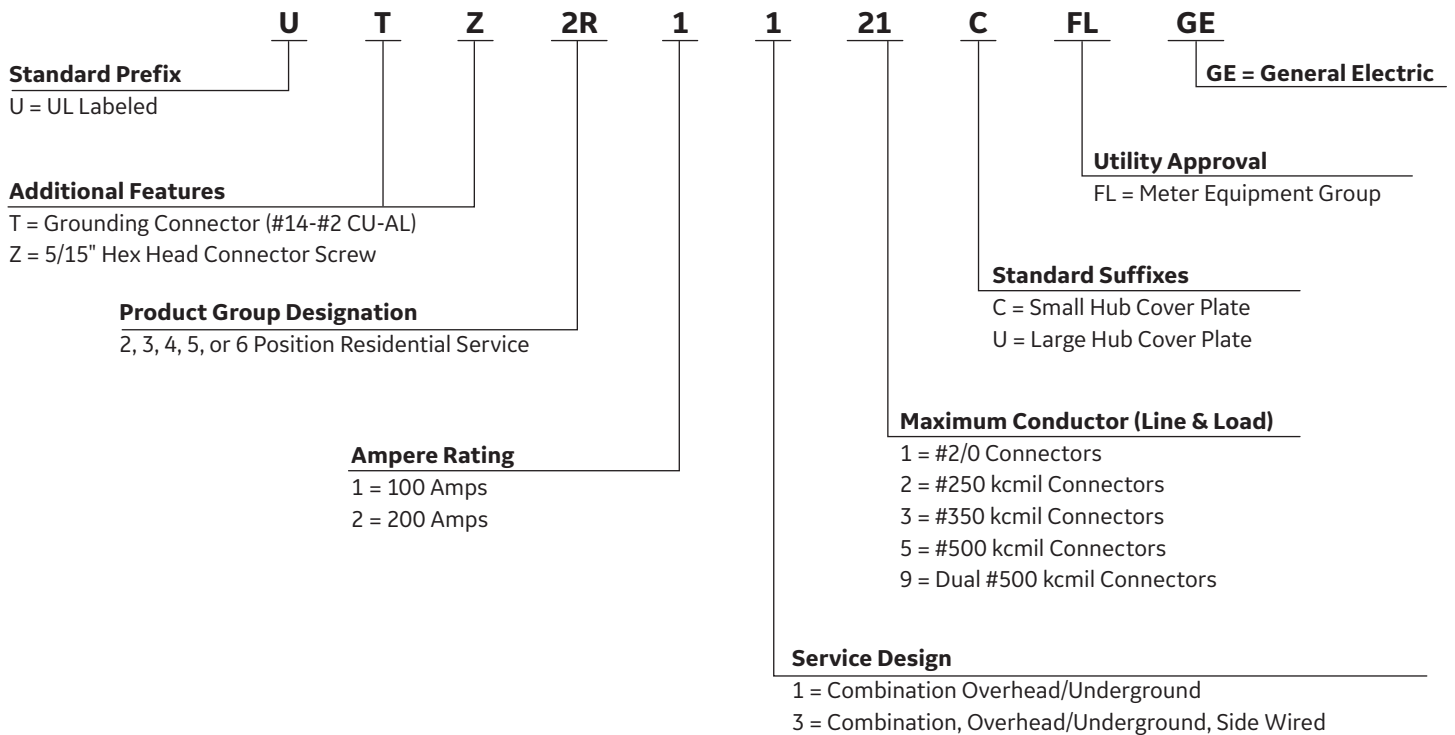

Single Phase, 600V

Amp	Gang	Catalog Number Ringless	Feed Type	Overhead/Underground Line Feed	Line Wire Range	Ground Lug Size	Triplex Ground	No. of Terminals	Lever Bypass	Horned Bypass	Hub Type	Enclosure N3R	UL & Utility Approved
100	2	UT2R1121CFLGE	Center	Top/Bottom	#6-250MCM Line #8-2/0 Load	(1) #14-2	Y	4	N	N	Small Hub Cover Plate	G90 Steel	UL, MEG
	3	UT3R1121CFLGE	Center	Top/Bottom	#6-250MCM Line #8-2/0 Load	(1) #14-2	Y	4	N	N	Small Hub Cover Plate		
	4	UT4R1121CFLGE	Center	Top/Bottom	#6-250MCM Line #8-2/0 Load	(1) #14-2	Y	4	N	N	Small Hub Cover Plate		
	5	UT5R1121CFLGE	Center	Top/Bottom	#6-250MCM Line #8-2/0 Load	(1) #14-2	Y	4	N	N	Small Hub Cover Plate		
	6	UT6R1131CFLGE	Center	Top/Bottom	#6-350MCM Line #8-2/0 Load	(1) #14-2	Y	4	N	N	Small Hub Cover Plate		
200	2	UT2R2332UFLGE	Center	Top/Bottom	#6-350MCM Line #8-250MCM Load	(1) #14-2	Y	4	N	N	Large Hub Cover Plate	G90 Steel	UL, MEG
	3	UT3R2332UFLGE	Center	Top/Bottom	#6-350MCM Line #8-250MCM Load	(1) #14-2	Y	4	N	N	Large Hub Cover Plate		
	4	UT4R2352UFLGE	Center	Top/Bottom	1/0-500MCM Line #8-250MCM Load	(1) #14-1/0	Y	4	N	N	Large Hub Cover Plate		
	5	UT5R2392UUFLGE	Center	Top/Bottom	1/0-500MCM Line #8-250MCM Load	(1) #14-2/0	Y	4	N	N	(2) Large Hub Cover Plates		
	6	UT6R2392UUFLGE	Center	Top/Bottom	1/0-500MCM Line #8-250MCM Load	(1) #14-2/0	Y	4	N	N	(2) Large Hub Cover Plates		

Horizontal Metering—MEG Approved

Enclosure Style

Catalog Number	Height (A) Inches	Width (B) Inches	Depth (C) Inches	Gross Weight lbs.	Enclosure Style
UTZ2R1121CFLGE	14.13	24.31	4.50	27.00	D
UTZ3R1121CFLGE	14.13	32.47	4.50	34.00	E
UTZ4R1121CFLGE	14.13	40.63	4.50	42.00	H
UTZ5R1121CFLGE	14.13	48.78	4.50	49.00	A
UTZ6R1131CFLGE	14.13	56.94	4.50	56.00	B
UT2R2332UFLGE	14.13	24.31	4.38	39.00	D
UT3R2332UFLGE	14.13	32.75	5.38	39.00	I
UT4R2352UFLGE	14.13	40.63	5.38	49.00	H
UT5R2392UUFLGE	14.13	54.78	5.38	63.00	A
UT6R2392UUFLGE	14.13	62.94	5.38	73.00	B

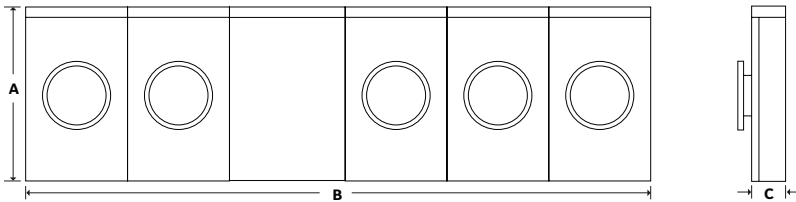

Figure A

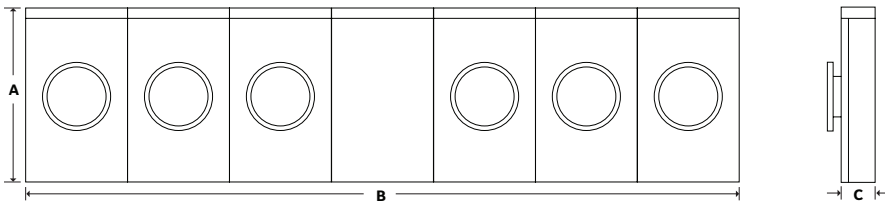

Figure B

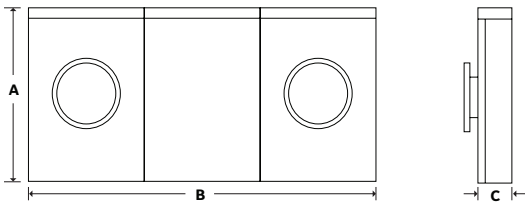

Figure D

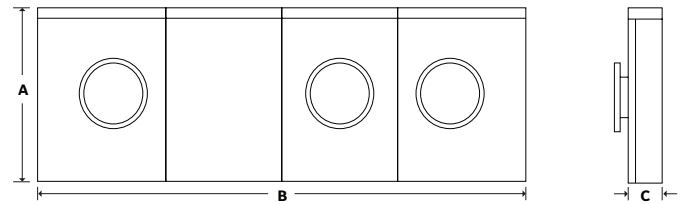

Figure E

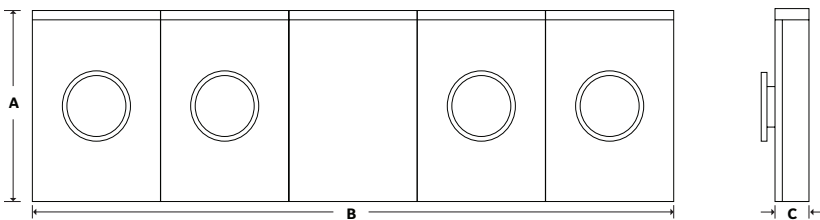

Figure H

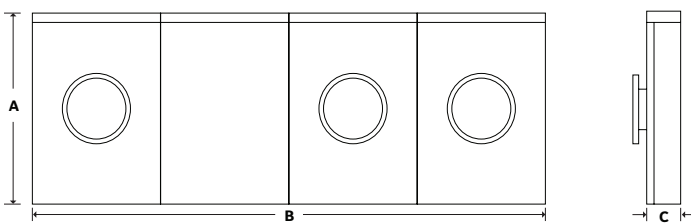
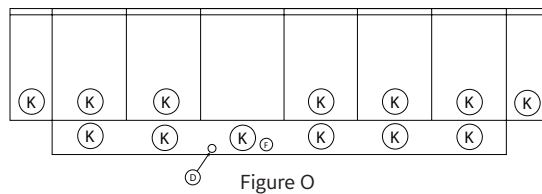
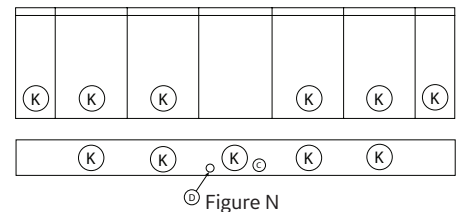
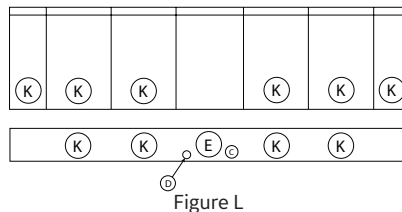
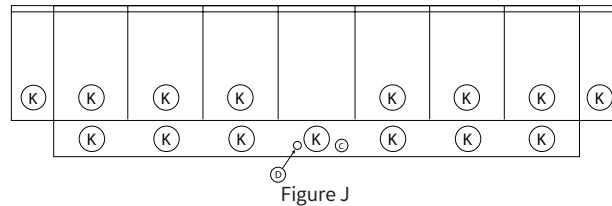
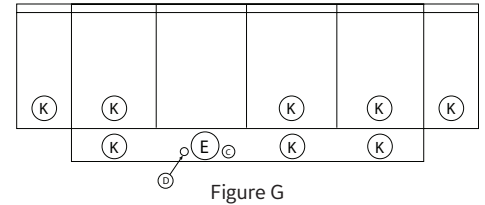
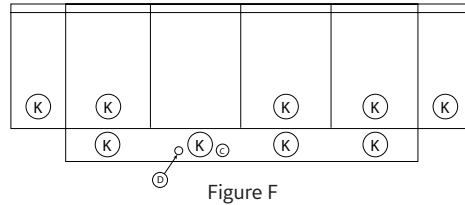
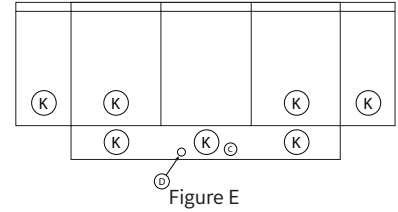
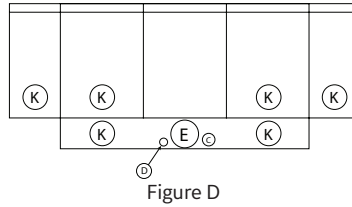
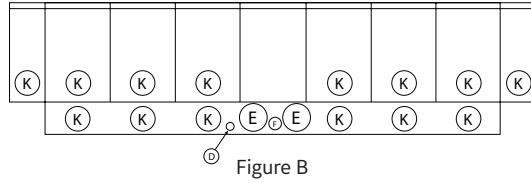
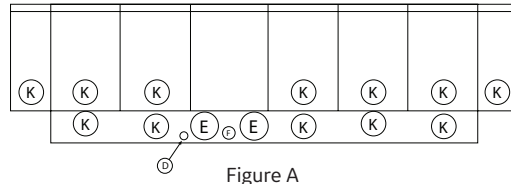

Figure I

Horizontal Metering—MEG Approved

Knockout Drawings and Dimensions

Catalog Number	Knockout Figure
UTZ2R1121CFLGE	E
UTZ3R1121CFLGE	F
UTZ4R1121CFLGE	N
UTZ5R1121CFLGE	O
UTZ6R1131CFLGE	J
UT2R2332UFLGE	D
UT3R2332UFLGE	G
UT4R2352UFLGE	L
UT5R2392UUFLGE	A
UT6R2392UUFLGE	B



Knockout Dimensions (inches)

C = 1/2

D = 5/16

E = 2, 2-1/2, 3

F = 1/2, 3/4

K = 1, 1-1/4, 1-1/2, 2, 2-1/2

Single Socket and Horizontal Metering

Accessories

Catalog Number	Description
ARP00118GE	One Lug for (2) #6-250MCM Cables/Phase
ARP00429GE	One Lug for (1) #4-600M Cables/Phase or (2) 1/0-250 Cables/Phase
ARP00129GE	Connector Kit #4-600MCM
ARP00326GE	5th Terminal Kit Lever Bypass
ARP00035GE	5th Terminal Kit Non-Lever Bypass
ARP00984GE	Anti-Inversion Clip (10 per package)
1006630AGE	Auxiliary Contacts Enclosure G90
ARP00920GE	Plastic Meter Socket Cover Plate



ARP00035GE

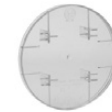

ARP00920GE

Hub Kits

Catalog Number	Description
ARP00003GE	1" Hub Kit, Small
ARP00004GE	1.25" Hub Kit, Small
ARP00005GE	1.5" Hub Kit, Small
ARP00006GE	2" Hub Kit, Small
ARP00007GE	2.5" Hub Kit, Small
ARP00017GE	2" Hub Kit, Large
ARP00018GE	2.5" Hub Kit, Large
ARP00019GE	3" Hub Kit, Large
ARP00020GE	3.5" Hub Kit, Large
ARP00021GE	4" Hub Kit, Large



Small Hub



Large Hub

Hub Cover Plates

Catalog Number	Description
ARP00002GE	Small Hub Cover Plate for 3 5/16" Hub Openings - Steel
ARP00008GE	Small Hub Cover Plate for 3 5/16" Hub Openings - Aluminum
ARP00016GE	Large Hub Cover Plate for 5" Hub Openings - Steel
ARP00023GE	Large Hub Cover Plate for 5" Hub Openings - Aluminum